

Stonel™ Quartz™ explosionproof,
nonincendive, I.S. & general
purpose on/off valve monitor

QX/QN/QG/QC series





Explosionproof valve monitoring

The Stonel Quartz is available in explosionproof (QX), nonincendive or intrinsically safe (QN), low temperature (QC) and general purpose (QG) versions. The robust epoxy-coated anodized aluminum construction, and optional stainless steel version, makes this platform extremely durable and well-suited for use in corrosive, heavy washdown environments. Options may be selected to accommodate most applications.

The Quartz series

This is a durable, corrosion-resistant, and versatile valve monitor for on/off applications, making it ideal for most of your process valve monitoring requirements.

Enclosures optimized for environment



QX/QC: Explosionproof, water tight and corrosion-resistant enclosure is approved for use in Div. 1/Zone 1 hazardous areas. Available options include stainless steel and epoxy-coated anodized aluminum.



QN: Nonincendive is approved for Div. 2/Zone 2 hazardous environments with proximity sensors using a clear cover. Intrinsically safe NAMUR sensors or passive switches are available for Div. 1/Zone 0 applications.

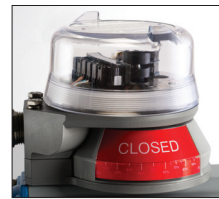

QG: General purpose features a clear Lexan® cover with mechanical switches. All enclosures are Type 4, 4x, and 6.

Save space with low profile design

Clearance above the actuator is critical in complex piping systems. Quartz boldly displays valve position and encloses all electrical components in an explosionproof compartment with less than 5" clearance requirement.

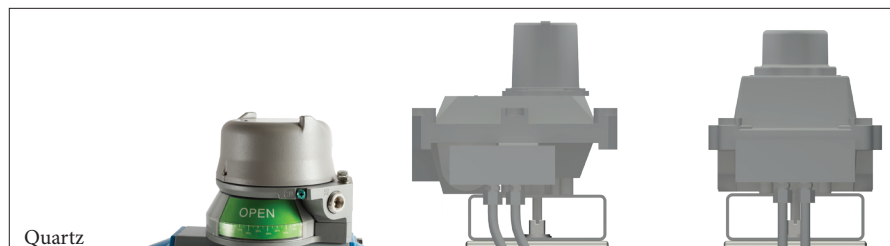

Features

- 1. Enclosures optimized for environment**
Available in three enclosure styles suitable for use in various process environment areas.
- 2. Rapid enclosure access**
Screw-on cover allows quick enclosure access, saving you valuable maintenance and set-up time. The cover provides a vaportight seal and allows entry to internal components in less than five seconds.
- 3. Faster wiring**
Pre-wired and labeled terminal strip enables quick, convenient attachment of field wires.
- 4. Wide variety of switching & communication**
Switching options include dual module sensors and communication, Maxx-Guard proximity switches, and mechanical switches. Continuous signal output is available in a 4-20 mA position transmitter.
- 5. Quick set cams are easy to adjust**
Touch and tune switch settings allow you to make adjustments in seconds without the use of tools.
- 6. Dual shaft o-ring seals eliminate corrosion**
Top inner and bottom outer shaft o-rings seal the drive bushing from both external corrosives and internal contaminants that enter the enclosure.
- 7. Special drive bushing assures long cycle life**
The oil impregnated bronze bushing maintains smooth operation and eliminates the potential for shaft seizure due to actuator shaft eccentricity.

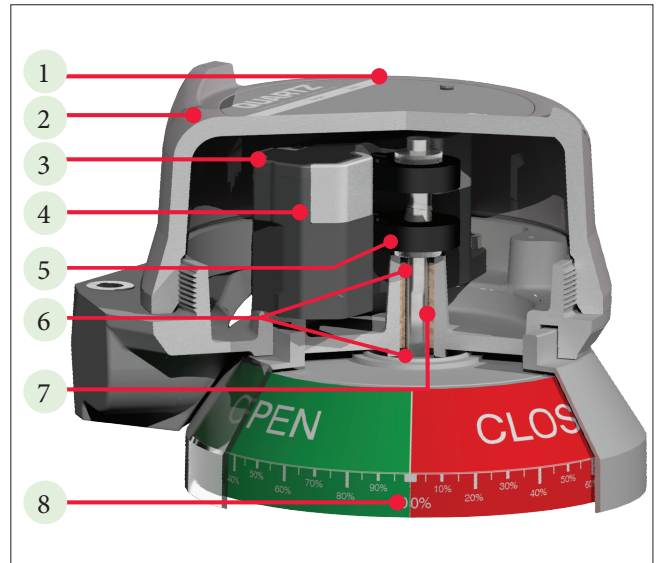

- 8. Bold space saving visual indication**
Visual indicator offers excellent viewability without sacrificing accessibility or adding to space requirements. Indicators are also available with continuous percentage or three-way indication. (See page 17).

Wide variety of switch/sensor functions

A wide variety of switch/sensor communications and position transmitters may be selected for the Quartz series. Options include 2, 4 or 6 mechanical or proximity switches, position transmitters with or without switches, and our dual module with two SST or two NAMUR sensors or AS-Interface or DeviceNet™ communication capabilities.

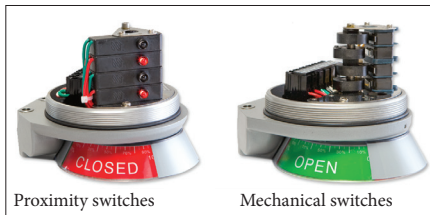

Speed installation with LED indication

Our coordinated visual indicator and LEDs give you an extra measure of safety and increased convenience during plant start-up and operation. Green visual indication and green LED means the valve is open and the computer circuit is properly operating. Red visual indication and red LED means the valve is closed and the computer is properly matched. All systems are functioning properly.



Eliminate seal fittings in Division 1 and 2 areas

FMus ratings certify the Quartz QX series with proximity switches for use without seal fittings in all hazardous areas. By passing special pressure piling tests, the all aluminum enclosure was certified for this elite distinction. Now, a time-consuming procedure can be safely eliminated in Division 1 and Division 2 areas.

Consolidate your components and minimize costs

The Quartz design offers up to three conduit entries with extra wire terminations. By terminating solenoid valves in the switch enclosure, significant savings are realized by eliminating a junction box, wiring, conduit materials, and labor.



Mounting kits

Kits may be ordered in 316 stainless steel. Consult factory for details.

Sealed mounting kit

Mounting to standard actuators is achieved with a bold visual indicator and sealed mounting system. Sealed mounting is exclusive with extended visual indicator option N. Adaptor plate is epoxy-coated anodized aluminum. All fasteners and couplings are stainless steel.



- Direct mount to actuators with VDI/VDE 3845 interface.
- Tolerant to vibration and mechanical stress.
- Prevents contamination and icing in coupling area.
- Available for all VDI/VDE 3845 (NAMUR) mounting configurations and most quarter-turn actuators.

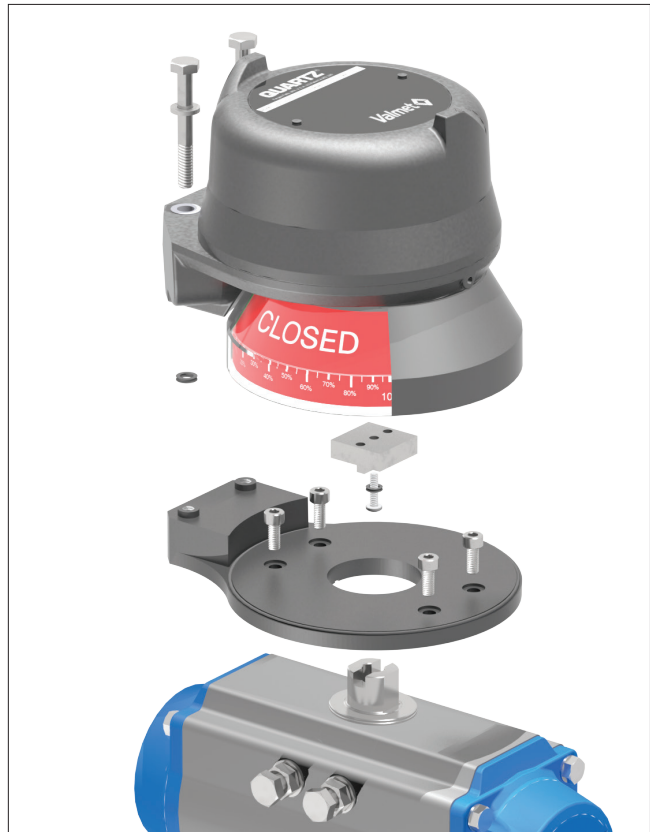

Quarter-turn actuators

Low profile convenient mounting systems are readily available in stainless steel for most standard actuators.



Manual valves

Proper fit and operation is assured with our custom designs for each manual valve. Hundreds of unique mounting systems have been designed and fabricated for manually operated valves.



Positioners

Quartz position transmitter and switches may be retrofitted directly to most positioners. 4-20 feedback may be provided on simple pneumatic positioners.



Linear operators

Precision ball joint connections attach the Quartz to valve travel stems. Stroke lengths ranging from 20 mm (¾" to 6") may be easily accommodated.



Quartz stainless steel option

For the most challenging environments

The explosionproof Quartz for process valve monitoring is available with a 316 stainless steel enclosure that is extremely durable and well-suited for use in corrosive, heavy washdown and high seas environments. A broad range of switching, position transmitters and communication options may be selected to accommodate most applications. You can attach the Quartz to quarter-turn actuators, manual operators, linear operators, and positioners using readily available stainless steel mounting systems.

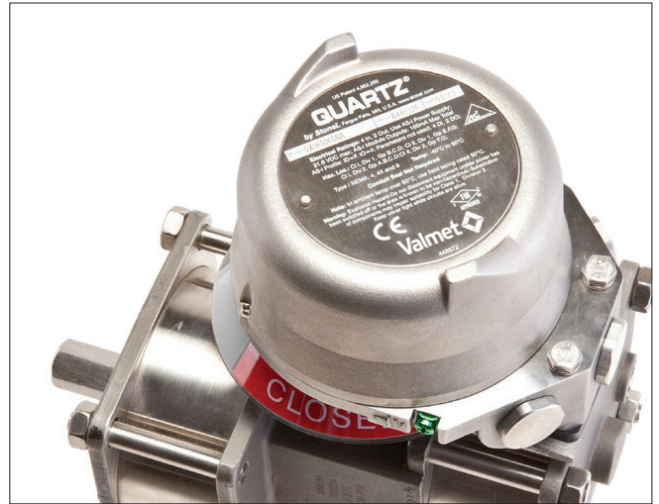

Position transmitter

4-20 mA position transmitter

Position transmitters provide a precise 4-20 mA signal on a two-wire DC loop. Control valves and dampers are accurately monitored through their range of travel offering assurance of exact valve position at all times. Several function options are available making it easy to find the correct product that fits your desired application. Choose a position transmitter with a standard potentiometer (5_), a vibration proof, high-performance potentiometer (7_), or the innovative non-contact magnetic resistive (mag res) digital transmitter (T_).

Digital transmitter

The digital transmitter utilizes an innovative non-contact magnetic sensor. The module features easy push button calibration to reduce set-up and commissioning time. With the bold red/green LED indication, the unit is visible from a distance and the calibration diagnostic LED indications confirm set up is valid. The position transmitter module housed with the Quartz platform is fully sealed and potted, providing reliable operation and outstanding vibration tolerance in tough applications.

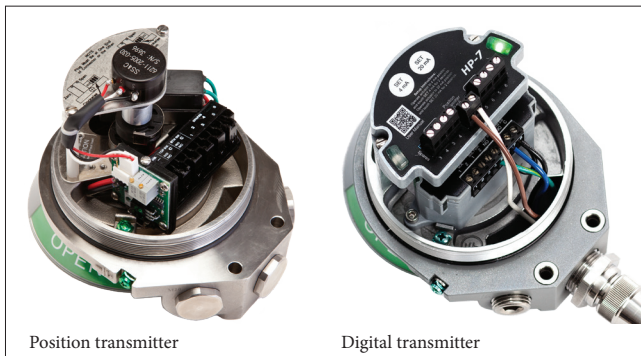

Position transmitter specifications

	Standard transmitter (5_)	High performance transmitter (7_)	Digital transmitter (T_)
Output	2-wire 4-20 mA	2-wire 4-20 mA	2-wire 4-20 mA
Supply source	10 - 40 VDC	10 - 40 VDC	10 - 40 VDC
Indication	None	None	Red/Green LED*
Span range	35° to 270°	35° to 270°	35° to 320°
Maximum loading	700 ohms @ 24 VDC	700 ohms @ 24 VDC	683 ohms @ 24 VDC
Refresh rate	< 1 ms	< 1 ms	< 5 ms
Linearity error	+/-0.85°	+/-0.35°	+/-0.35°
Cycle life	2 million rotations	50 million rotations	Unlimited
Vibration tolerance	Acceptable	Outstanding	Outstanding

* Open / Closed LED position indication and calibration status diagnostics

Electrical schematic

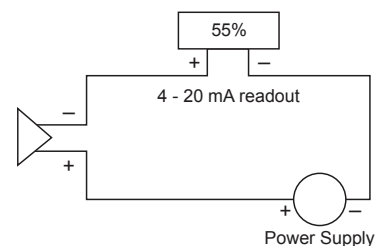

Sensors and communications

Dual module system

The Quartz series is available with the dual module in its various configurations. Two solid state sensors and/or communications and other electronics are sealed in for the ultimate in reliability and convenience. All dual module versions have a five year warranty.

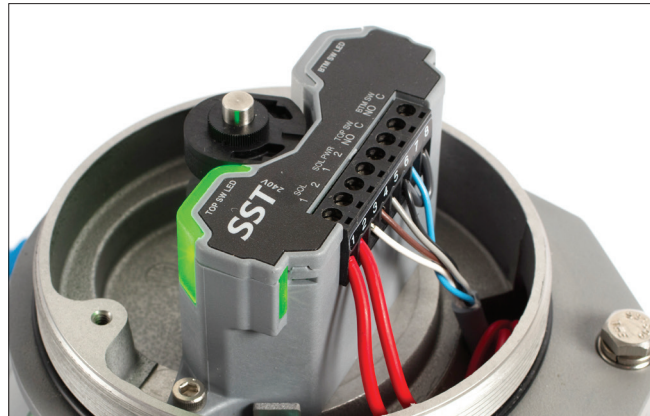

Switching and sensor specifications	
SST switching sensors (35)	
Configuration	(2) SST solid state sensors Wire terminations for one or two solenoids
Operations	Normally open (NO) for Normally closed (NC), consult factory
Maximum current inrush	1.0 amp
Maximum current continuous	0.1 amp
Minimum on current	0.5 mA
Maximum leakage current	0.25 mA (AC) 0.15 mA (DC)
Voltage range	20 - 250 VAC 8 - 250 VDC
Maximum voltage drop	6.5 volts @ 10 mA 7.2 volts @ 100 mA

Wiring diagram (35)	

Sensor specifications	
NAMUR sensor (45)	
Configuration	(2) NAMUR sensors (EN 60947-5-6; I.S.) Wire terminations for one or two solenoids
Operation	Normally closed NAMUR sensors (solid state)
Voltage range	5 - 25 VDC
Current ratings	Target on I < 1 mA Target off I > 3 mA

Wiring diagram (45)	
	NAMUR

Sensor specifications	
P+F NAMUR sensors (_A and _N)	
Configuration	(2) NAMUR sensors (EN 60947-5-6) _A sensor NJ2-12GK-SN _N sensor NJ2-V3-N-V5
Operation	NO/NC (cam selectable)
Current ratings	Target present Current < 1.0 mA Target absent Current > 3.0 mA
Voltage range	5 - 25 VDC
Operating life	Unlimited

P+F NAMUR sensors (_B)	
Configuration	(2) NAMUR NO sensors (EN 60947-5-2) NJ5-30GK-S1N
Operation	NO/NC (cam selectable)
Current ratings	Target present Current > 3.0 mA Target absent Current < 1.0 mA
Voltage range	5 - 25 VDC
Operating life	Unlimited

Sensors and communications

Valve Communication Terminal (VCT) specifications

AS-Interface (96)

Configuration	(2) Discrete sensor inputs (2) Auxiliary discrete inputs (2) Power outputs (solenoids)
Maximum current	160 mA, both outputs combined
Auxiliary inputs	24 VDC @ 2 mA (self-powered)
Output	4 watts @ 24 VDC both outputs combined
Outputs, voltage	21 - 26 VDC
Configuration code	ID=F, IO=4; user defined (4DI/2DO)
AS-i version	3.0
Devices per network	31

Wiring diagram (96)

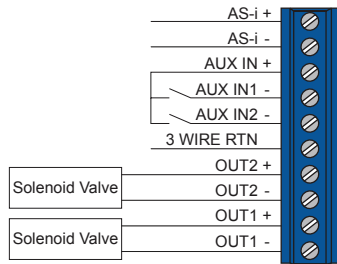

AS-Interface VCT with extended addressing (97)

Configuration	(2) Discrete sensor inputs (2) Auxiliary discrete inputs (1) Power output (solenoid)
Maximum current	100 mA
Auxiliary inputs	24 VDC @ 2 mA (self-powered)
Output	2 watts @ 24 VDC
Output, voltage	21 - 26 VDC
Configuration code	ID=A, IO=4; user defined (4DI/1DO)
AS-i version	3.0
Devices per network	62

Wiring diagram (97)

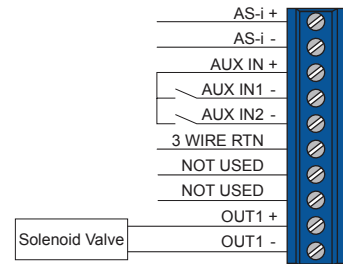

Valve Communication Terminal (VCT) specifications

DeviceNet™ (92)

Configuration	(2) Discrete inputs (open and closed) (2) Power outputs (solenoids) (1) 4-20 mA auxiliary analog input, 10-bit resolution; no additional power source required
Transmission rate	Software selectable 125K, 250K or 500K baud
Messaging	Polling, cyclic and change of state
Outputs	4 watts @ 24 VDC outputs combined
Outputs, voltage	24 VDC (with input voltage ranging from 10 - 24 VDC)
Other features	Predetermined output fail state

Wiring diagram (92)

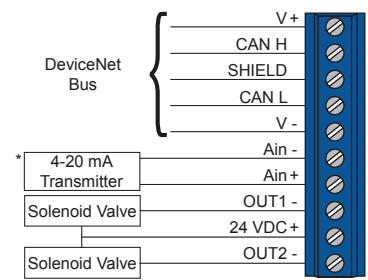

* 4-20 mA transmitter not included

Sensors and switches

Maxx-Guard proximity switch

Maxx-Guard hermetically-sealed switches are suitable for computer input circuits and general purpose applications. SPDT tungsten contacts are designed for 125 VAC computer inputs and 240 VAC moderate power applications. SPDT rhodium contacts are suitable for both 24 VDC and 120 VAC computer inputs. SPST ruthenium contacts are ideal for either 24 VDC or 125 VAC low power computer inputs.



Maxx-Guard proximity switch Single-Pole Single-Throw (SPST)

J switch	
Configuration	SPST NO; passive (intrinsically safe)
Electrical ratings	0.10 amp @ 10 - 30 VDC
Maximum voltage drop	0.1 volts @ 10 mA 0.5 volts @ 100 mA
Contact composition	Ruthenium

P switch	
Configuration	SPST NO
Electrical ratings	0.15 amp @ 125 VAC/30 VDC
Maximum voltage drop	0.1 volts @ 10 mA 0.5 volts @ 100 mA
Contact composition	Ruthenium



Maxx-Guard proximity switch Single-Pole Double-Throw (SPDT)

G switch	
Configuration	SPDT
Electrical ratings	0.2 amp @ 120 VAC 0.30 amp @ 24 VDC
Maximum voltage drop	0.1 volts @ 10 mA 0.5 volts @ 100 mA
Contact composition	Rhodium

H switch	
Configuration	SPDT
Electrical ratings	240 volts max; 3 amps max 100 watts max; 2.0 watts min
Maximum voltage drop	0.1 volts @ 10 mA 0.5 volts @ 100 mA
Contact composition	Tungsten

M switch	
Configuration	SPDT; passive (intrinsically safe)
Electrical ratings	0.10 amp @ 10 - 30 VDC
Maximum voltage drop	0.1 volts @ 10 mA 0.5 volts @ 100 mA
Contact composition	Rhodium

S switch	
Configuration	SPDT (LED)
Electrical ratings	0.1 amp @ 120 VAC 0.1 amp @ 24 VDC
Maximum voltage drop	3.5 volts @ 10 mA 6.5 volts @ 100 mA
Contact composition	Rhodium

S switch	
Configuration	SPDT (LED)
Electrical ratings	0.1 amp @ 120 VAC 0.1 amp @ 24 VDC
Maximum voltage drop	3.5 volts @ 10 mA 6.5 volts @ 100 mA
Contact composition	Rhodium

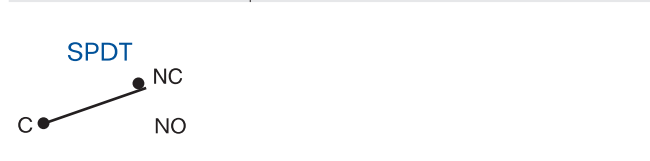

Specifications

Temperature range	-40° C to 80° C (-40° F to 176° F)
Seal	Hermetically-sealed
Operating life	5 million cycles
Warranty	Two years

Sensors and switches

Mechanical switch (SPDT)

Low cost single-pole double-throw mechanical switches with silver contacts are recommended for high power 125 VAC applications. Gold contacts may be used in 24 VDC computer input applications when cycle life does not exceed 100,000 operations.

Mechanical switch (SPDT)

Silver contacts (V switch)

Electrical ratings 10 amp @ 125 / 250 VAC
0.5 amp @ 125 VDC

Operating life 400,000 cycles

Not recommended for electrical circuits operating at less than 20 mA @ 24 VDC.

Gold contacts (W switch)

Electrical ratings 1 amp @ 125 VAC
0.5 amp @ 30 VDC

Operating life 100,000 cycles



Mechanical switch (DPDT)

Double-pole double-throw mechanical switches enable two electrical circuits to be activated simultaneously. Each switch circuit is electrically isolated from the other. As with standard silver contacts, DPDT switches are designed to operate in high-power applications.

Mechanical switch (DPDT)

14 switch

Electrical ratings 4.5 amp @ 125 / 250 VAC, 24 - 125 VDC

Operating life 250,000 (VAC), 100,000 (VDC) cycles

Not recommended for electrical circuits operating at less than 20 mA @ 24 VDC.

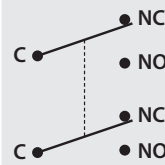

SST switching sensor

Solid state SST proximity sensors are ideal for use in AC and DC computer input circuits.

SST switching sensors

4X switch

Operation NO/NC (cam selectable)

Maximum inrush current 1.0 amps @ 125 VAC/VDC

Maximum continuous current 0.1 amps @ 125 VAC/VDC

Minimum on current 2.0 mA

Leakage current Less than 0.50 mA

Voltage range 24 - 125 VAC
8 - 125 VDC

Maximum voltage drop 6.5 volts @ 10 mA
7.5 volts @ 100 mA

Operating life Unlimited

Warranty Five years

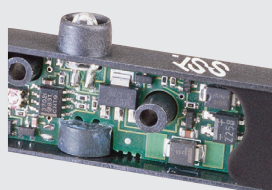

Model selector

SERIES
QX Explosionproof dual modules and VCTs

FUNCTIONS
Sensor/switching modules (proximity type)
35 SST Universal NO switching sensor dual module
45 NAMUR dual module (EN 60947-5-6; I.S.)

Valve Communication Terminals (VCTs)
92 DeviceNet™
96 AS-Interface
97 AS-Interface (with extended addressing)

ENCLOSURE
E Aluminum North American (NEC/CEC)
R Aluminum International (IEC)
F Aluminum Brazilian
CR Aluminum China (CCC)
S* Stainless steel North American (NEC/CEC)
T* Stainless steel International (IEC)
M* Stainless steel Brazilian
CT* Stainless steel China (CCC)
* Available with 03 or 06 conduit entry only

CONDUIT ENTRIES
02 (1) ¼" NPT & (1) ½" NPT
03 (1) ¼" NPT & (2) ½" NPT
05 (2) M20
06 (3) M20

OUTPUT
S Short visual indicator
N Extended visual indicator
H Neles "H" coupler

VISUAL INDICATOR [see chart on page 17]
RA Red closed/green open
GA Green closed/red open
1A T-1 three way flow path
2A T-2 three way flow path
3A T-3 three way flow path
4A T-4 three way flow path
5A T-5 three way flow path
0A No mechanical indication
XA Special
CA Continuous

Model number example
QX 35 E 02 N RA - OPTIONAL

MODEL NUMBER **PARTNERSHIP ID**
Mounting hardware required and sold separately. Some models may include 5-digit identification suffix.

Model selector

SERIES
QX Explosionproof proximity switches

FUNCTIONS
Sensors
2E (2) P+F special 3-wire NPN sensor; NBB2-V3-E0-V5
2F (2) PNP solid state 3-wire P+F sensor; NBB2-V3-E2-V5
2G (2) SPDT Maxx-Guard (low current) dual module
2H (2) SPDT Maxx-Guard (3 amp) dual module
2L (2) SPST Maxx-Guard (LED)
2P (2) SPST Maxx-Guard
2S (2) SPDT Maxx-Guard (LED) dual module
4G (4) SPDT Maxx-Guard (low current)
4H (4) SPDT Maxx-Guard (3 amp)
4L (4) SPST Maxx-Guard (LED)
4P (4) SPST Maxx-Guard
4S (4) SPDT Maxx-Guard (LED)

ENCLOSURE
E Aluminum North American (NEC/CEC)
R Aluminum International (IEC)
F Aluminum Brazilian
CR Aluminum China (CCC)
S* Stainless steel North American (NEC/CEC)
T* Stainless steel International (IEC)
M* Stainless steel Brazilian
CT* Stainless steel China (CCC)
* Available with 03 or 06 conduit entry only

CONDUIT ENTRIES
02 (1) ¼" NPT & (1) ½" NPT
03 (1) ¼" NPT & (2) ½" NPT
05 (2) M20
06 (3) M20

OUTPUT
S Short visual indicator
N Extended visual indicator
H Neles "H" coupler

VISUAL INDICATOR [see chart on page 17]
RA Red closed/green open
GA Green closed/red open
1A T-1 three way flow path
2A T-2 three way flow path
3A T-3 three way flow path
4A T-4 three way flow path
5A T-5 three way flow path
0A No mechanical indication
XA Special
CA Continuous

Model number example
QX 2G R 02 N RA - OPTIONAL

MODEL NUMBER **PARTNERSHIP ID**
Mounting hardware required and sold separately. Some models may include 5-digit identification suffix.

Model selector

SERIES	
QX	Explosionproof mechanical switches and position transmitters
FUNCTIONS	
Mechanical switches	
2V	(2) SPDT switches
2W	(2) SPDT switches, gold contact
4V	(4) SPDT switches
4W	(4) SPDT switches, gold contact
14	(2) DPDT switches
Position transmitters	
5O	Standard with no switches
5G	Standard with (2) SPDT Maxx-Guard (low current)
5V	Standard with (2) SPDT mechanical switches
5W	Standard with (2) SPDT mechanical switches, gold contact
53	Standard with SST (33) NO switching sensor dual module
54	Standard with NAMUR (44) dual module (EN 60947-5-6; I.S.)
7O	High performance (HP) with no switches
7G	HP with (2) SPDT Maxx-Guard (low current)
73	HP with SST (33) NO switching sensor dual module
74	HP with NAMUR (44) dual module (EN 60947-5-6; I.S.)
TO	4-20 mA non-contact with no switches
TT	4-20 mA non-contact with SST (35) NO switching sensor dual module
TR	4-20 mA non-contact with NAMUR (45) dual module (EN 60947-5-6; I.S.)
ENCLOSURE	
E	Aluminum North American (NEC/CEC)
R	Aluminum International (IEC)
F	Aluminum Brazilian
CR	Aluminum China (CCC)
S*	Stainless steel North American (NEC/CEC)
T*	Stainless steel International (IEC)
M*	Stainless steel Brazilian
CT*	Stainless steel China (CCC)
* Available with 03 or 06 conduit entry only	
CONDUIT ENTRIES	
02	(1) 3/4" NPT & (1) 1/2" NPT
03	(1) 3/4" NPT & (2) 1/2" NPT
05	(2) M20
06	(3) M20
OUTPUT	
S	Short visual indicator
N	Extended visual indicator
H	Neles "H" coupler
VISUAL INDICATOR <small>[see chart on page 17]</small>	
RA	Red closed/green open
GA	Green closed/red open
1A	T-1 three way flow path
2A	T-2 three way flow path
3A	T-3 three way flow path
4A	T-4 three way flow path
5A	T-5 three way flow path
0A	No mechanical indication
XA	Special
CA	Continuous
Model number example	
QX	2V E 02 N RA - OPTIONAL
MODEL NUMBER	PARTNERSHIP ID
Mounting hardware required and sold separately.	Some models may include 5-digit identification suffix.

Model selector

SERIES	
QX	International dual Ex d / Ex ia certified
FUNCTIONS	
Sensor/switching modules (proximity type)	
45	NAMUR dual module (EN 60947-5-6; I.S.)
Sensors	
2A	(2) P+F; NJ2-12GK-SN
2B	(2) P+F; NJ5-30GK-S1N
2J	(2) SPST (passive)
2M	(2) SPDT (passive) dual module
2N	(2) P+F NAMUR sensors; NJ2-V3-N
4A	(4) P+F; NJ2-12GK-SN
4J	(4) SPST (passive)
4M	(4) SPDT (passive)
Position transmitters	
TO	4-20 mA non-contact with no switches
TR	4-20 mA non-contact with NAMUR (45) dual module (EN 60947-5-6; I.S.)
ENCLOSURE	
R	Aluminum International (IEC)
CR	Aluminum China (CCC)
T*	Stainless steel International (IEC)
CT*	Stainless steel China (CCC)
* Available with 03 or 06 conduit entry only	
CONDUIT ENTRIES	
02	(1) 3/4" NPT & (1) 1/2" NPT
03	(1) 3/4" NPT & (2) 1/2" NPT
05	(2) M20
06	(3) M20
OUTPUT	
S	Short visual indicator
N	Extended visual indicator
H	Neles "H" coupler
VISUAL INDICATOR <small>[see chart on page 17]</small>	
RA	Red closed/green open
GA	Green closed/red open
1A	T-1 three way flow path
2A	T-2 three way flow path
3A	T-3 three way flow path
4A	T-4 three way flow path
5A	T-5 three way flow path
0A	No mechanical indication
XA	Special
CA	Continuous
Model number example	
QX	45 R 02 N RA - OPTIONAL
MODEL NUMBER	PARTNERSHIP ID
Mounting hardware required and sold separately.	Some models may include 5-digit identification suffix.

Model selector	
SERIES	
QN Nonincendive dual modules and VCTs	
FUNCTIONS	
Sensor/switching modules (proximity type)	
35	SST Universal NO switching sensor dual module
Valve Communication Terminals (VCTs)	
92	DeviceNet™
96	AS-Interface
97	AS-Interface with extended addressing
ENCLOSURE	
Clear cover	
C	North American (NEC/CEC)
D	International (IEC)
CONDUIT ENTRIES	
02	(1) ¾" NPT & (1) ½" NPT
03	(1) ¾" NPT & (2) ½" NPT
05	(2) M20
06	(3) M20
OUTPUT	
S	Short visual indicator
N	Extended visual indicator
H	Neles "H" coupler
VISUAL INDICATOR [see chart on page 17]	
RA	Red closed/green open
GA	Green closed/red open
1A	T-1 three way flow path
2A	T-2 three way flow path
3A	T-3 three way flow path
4A	T-4 three way flow path
5A	T-5 three way flow path
0A	No mechanical indication
XA	Special
CA	Continuous
Model number example	
QN 35 C 02 N RA -	OPTIONAL
MODEL NUMBER	PARTNERSHIP ID
Mounting hardware required and sold separately.	Some models may include 5-digit identification suffix.

Model selector	
SERIES	
QN Nonincendive proximity switches	
FUNCTION	
Sensors	
2F	(2) PNP solid state 3-wire P+F sensor; NBB2-V3-E2-V5
2G	(2) SPDT Maxx-Guard (low current) dual module
2H	(2) SPDT Maxx-Guard (3 amp) dual module
2L	(2) SPST Maxx-Guard (LED)
2P	(2) SPST Maxx-Guard
2S	(2) SPDT Maxx-Guard (LED) dual module
4G	(4) SPDT Maxx-Guard (low current)
4H	(4) SPDT Maxx-Guard (3 amp)
4L	(4) SPST Maxx-Guard (LED)
4P	(4) SPST Maxx-Guard
4S	(4) SPDT Maxx-Guard (LED)
4X	(4) SST sensor (LED)
ENCLOSURE	
Clear cover	
C	North American (NEC/CEC)
D	International (IEC)
CONDUIT ENTRIES	
02	(1) ¾" NPT & (1) ½" NPT
03	(1) ¾" NPT & (2) ½" NPT
05	(2) M20
06	(3) M20
OUTPUT	
S	Short visual indicator
N	Extended visual indicator
H	Neles "H" coupler
VISUAL INDICATOR [see chart on page 17]	
RA	Red closed/green open
GA	Green closed/red open
1A	T-1 three way flow path
2A	T-2 three way flow path
3A	T-3 three way flow path
4A	T-4 three way flow path
5A	T-5 three way flow path
0A	No mechanical indication
XA	Special
CA	Continuous
Model number example	
QN 2G C 02 N RA -	OPTIONAL
MODEL NUMBER	PARTNERSHIP ID
Mounting hardware required and sold separately.	Some models may include 5-digit identification suffix.

Model selector

SERIES
 QN Intrinsically safe (I.S.) proximity switches and position transmitters

FUNCTIONS
 Sensor/switching modules (proximity type)
 45 NAMUR dual module (EN 60947-5-6; I.S.)

Sensor
 2A (2) P+F; NJ2-12GK-SN
 2B (2) P+F; NJ5-30GK-S1N
 2J (2) SPST (passive)
 2M (2) SPDT (passive) dual module
 2N (2) P+F NAMUR sensors; NJ2-V3-N
 4J (4) SPST (passive)
 4M (4) SPDT (passive)
 4N (4) P+F NAMUR sensors; NJ2-V3-N

Position transmitters
 5O Standard with no switches
 7O High performance (HP) with no switches
 TO 4-20 mA non-contact with no switches
 TR 4-20 mA non-contact with NAMUR (45) dual module (EN 60947-5-6; I.S.)

ENCLOSURE
 Clear cover
 C North American (NEC/CEC)
 D International (IEC)
 CD Chinese (CCC)
 Aluminum cover [not explosion proof]
 E North American (NEC/CEC)
 R International (IEC)
 CR Chinese (CCO)

CONDUIT ENTRIES
 02 (1) 3/4" NPT & (1) 1/2" NPT
 03 (1) 3/4" NPT & (2) 1/2" NPT
 05 (2) M20
 06 (3) M20

OUTPUT
 S Short visual indicator
 N Extended visual indicator
 H Neles "H" coupler

VISUAL INDICATOR [see chart on page 17]
 RA Red closed/green open
 GA Green closed/red open
 1A T-1 three way flow path
 2A T-2 three way flow path
 3A T-3 three way flow path
 4A T-4 three way flow path
 5A T-5 three way flow path
 0A No mechanical indication
 XA Special
 CA Continuous

Model number example
 QN 45 C 02 N RA - OPTIONAL

MODEL NUMBER	PARTNERSHIP ID
Mounting hardware required and sold separately.	Some models may include 5-digit identification suffix.

Model selector

SERIES
 QN Nonincendive proximity switches and position transmitters

FUNCTIONS
 Position transmitters
 5O Standard with no switches
 5G Standard with (2) SPDT Maxx-Guard (low current)
 7O High performance (HP) with no switches
 7G High performance (HP) with (2) SPDT Maxx-Guard (low current)
 TO 4-20 mA non-contact with no switches
 TT 4-20 mA non-contact with SST (35) NO switching sensor dual module

ENCLOSURE
 Clear cover
 C North American (NEC/CEC)
 D International (IEC)

CONDUIT ENTRIES
 02 (1) 3/4" NPT & (1) 1/2" NPT
 03 (1) 3/4" NPT & (2) 1/2" NPT
 05 (2) M20
 06 (3) M20

OUTPUT
 S Short visual indicator
 N Extended visual indicator
 H Neles "H" coupler

VISUAL INDICATOR [see chart on page 17]
 RA Red closed/green open
 GA Green closed/red open
 1A T-1 three way flow path
 2A T-2 three way flow path
 3A T-3 three way flow path
 4A T-4 three way flow path
 5A T-5 three way flow path
 0A No mechanical indication
 XA Special
 CA Continuous

Model number example
 QN 5O C 02 N RA - OPTIONAL

MODEL NUMBER	PARTNERSHIP ID
Mounting hardware required and sold separately.	Some models may include 5-digit identification suffix.

Model selector	
SERIES	
QC Low temperature, explosionproof dual modules	
FUNCTIONS	
Sensor/switching modules (proximity type)	
35	SST Universal NO switching sensor dual module
45	NAMUR dual module (EN 60947-5-6; I.S.)
ENCLOSURE	
E	Aluminum North American (NEC/CEC)
R	Aluminum International (IEC)
CR	Aluminum Chinese (CCC)
S	Stainless steel North American (NEC/CEC)
T	Stainless steel International (IEC)
CT	Stainless steel Chinese (CCC)
CONDUIT ENTRIES	
03	(1) ¼" NPT & (2) ½" NPT
06	(3) M20
OUTPUT	
S	Short visual indicator
N	Extended visual indicator
H	Neles "H" coupler
VISUAL INDICATOR	
RA	Red closed/green open
GA	Green closed/red open
1A	T-1 three way flow path
2A	T-2 three way flow path
3A	T-3 three way flow path
4A	T-4 three way flow path
5A	T-5 three way flow path
0A	No mechanical indication
XA	Special
CA	Continuous
Model number example	
QC 35 E 02 N RA -	OPTIONAL
MODEL NUMBER	PARTNERSHIP ID
Mounting hardware required and sold separately.	Some models may include 5-digit identification suffix.

Model selector	
SERIES	
QC Low temperature, explosionproof mechanical switches	
FUNCTIONS	
Mechanical switches	
2V	(2) SPDT switches
2W	(2) SPDT switches, gold contact
4V	(4) SPDT switches
4W	(4) SPDT switches, gold contact
ENCLOSURE	
E	Aluminum North American (NEC/CEC)
R	Aluminum International (IEC)
CR	Aluminum Chinese (CCC)
S	Stainless steel North American (NEC/CEC)
T	Stainless steel International (IEC)
CT	Stainless steel Chinese (CCC)
CONDUIT ENTRIES	
03	(1) ¼" NPT & (2) ½" NPT
06	(3) M20
OUTPUT	
S	Short visual indicator
N	Extended visual indicator
H	Neles "H" coupler
VISUAL INDICATOR	
RA	Red closed/green open
GA	Green closed/red open
1A	T-1 three way flow path
2A	T-2 three way flow path
3A	T-3 three way flow path
4A	T-4 three way flow path
5A	T-5 three way flow path
0A	No mechanical indication
XA	Special
CA	Continuous
Model number example	
QC 2V E 02 N RA -	OPTIONAL
MODEL NUMBER	PARTNERSHIP ID
Mounting hardware required and sold separately.	Some models may include 5-digit identification suffix.

Model selector	
SERIES	
QG	General purpose mechanical switches (clear cover)
FUNCTION	
Mechanical switches	
2V	(2) SPDT switches
2W	(2) SPDT switches, gold contact
4V	(4) SPDT switches
4W	(4) SPDT switches, gold contact
14	(2) DPDT switches
ENCLOSURE	
C	General purpose, universal
CONDUIT ENTRIES	
02	(1) ¾" NPT & (1) ½" NPT
03	(1) ¾" NPT & (2) ½" NPT
05	(2) M20
06	(3) M20
OUTPUT	
S	Short visual indicator
N	Extended visual indicator
H	Neles "H" coupler
VISUAL INDICATOR	
RA	Red closed/green open
GA	Green closed/red open
1A	T-1 three way flow path
2A	T-2 three way flow path
3A	T-3 three way flow path
4A	T-4 three way flow path
5A	T-5 three way flow path
0A	No mechanical indication
XA	Special
CA	Continuous
Model number example	
QG	2V C 02 N RA - OPTIONAL
MODEL NUMBER	PARTNERSHIP ID
Mounting hardware required and sold separately.	Some models may include 5-digit identification suffix.

Specifications	
Materials of construction	
Housing & cover	Epoxy-coated anodized marine grade aluminum or stainless steel
Clear cover & indicator	Lexan® polycarbonate
Elastomer seals	Buna-N; optional EPDM
Drive shaft	Stainless steel
Drive bushing	Bronze, oil impregnated
Fasteners	Stainless steel
Operating temperature range	-40° C to 80° C (-40° F to 176° F) (Typical) -55° C to 80° C (-67° F to 176° F) (QC series only)
Warranty	
Mechanical components	Two years
SST & dual modules	Five years
Lexan® is a registered trademark of General Electric Corporation.	

Ratings	
Explosionproof <i>(Ex d, Zone 1 or Class I and II, Div. 1)</i>	QX models*
Nonincendive <i>(Class I and II, Div. 2)</i>	QN models*
Intrinsically safe <i>(Ex ia, Zone 0 or Class I and II, Div. 1)</i>	Functions 45, _A, _J, _M and _N*
Enclosure protection	
Type 4, 4X and 6	All models
Ingress Protection 66 and 67	All models
Approvals*	See manufacturer's website
* Only models listed on valmet.com/flowcontrol website are approved per specific rating.	

Dimensions

Output option "S" - Short visual indicator

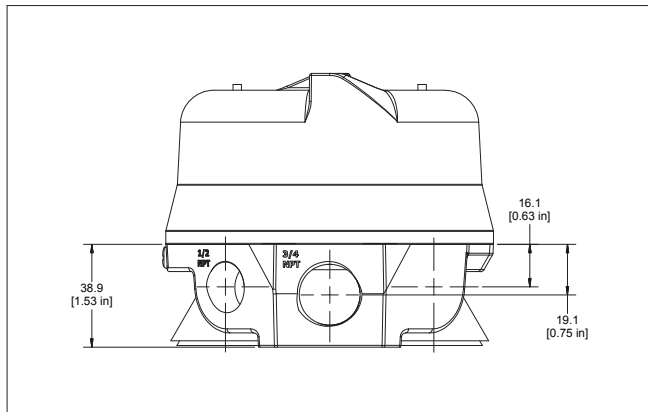
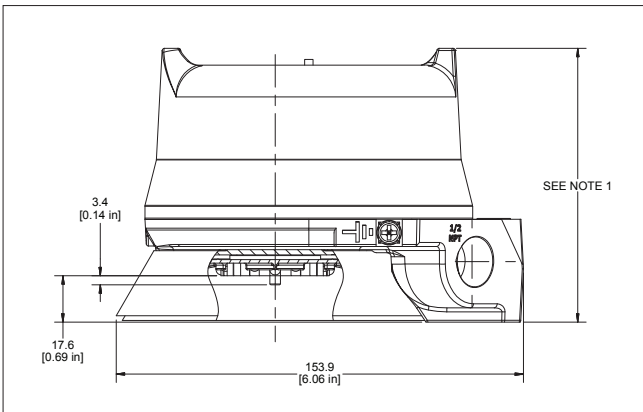

Output option "N" - Extended visual indicator

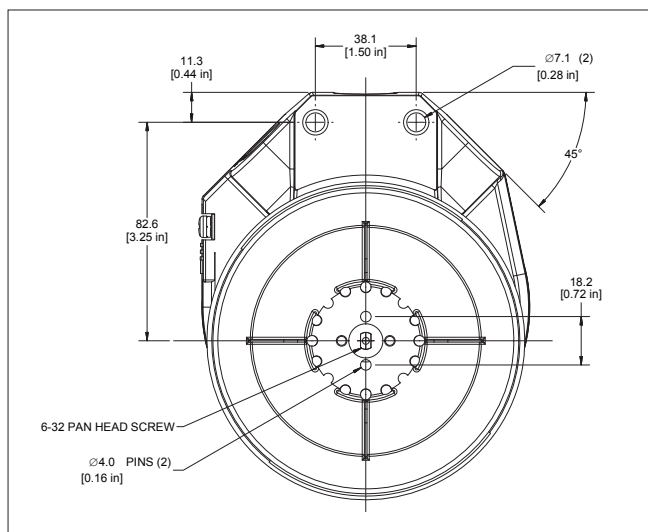
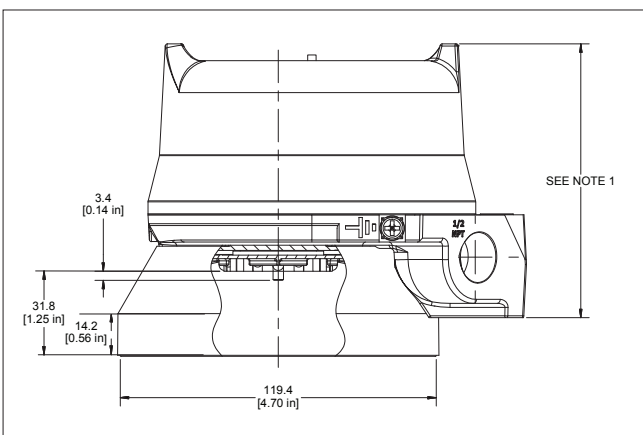



NOTE 1

Cover height varies based on model number.
Dual module and 2-switch models use short covers.

- Short cover = 102 mm [4.0"]
- Medium cover = 123.4 mm [4.86"]
- Tall cover = 155.4 mm [6.12"]

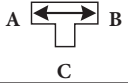
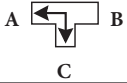
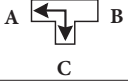
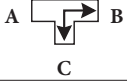
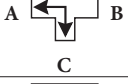
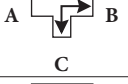
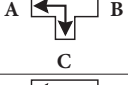
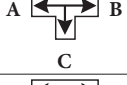
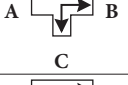
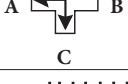
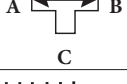
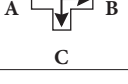
Visual indicator designations

DESIGNATION	0°	90°	180°
R	RED CLOSED	GREEN OPEN	
G	GREEN CLOSED	RED OPEN	
1			
2			
3		CLOSED	
4			
5			
C	 0% 50% 100%		
X	Specialty configuration - please consult factory		

Valmet Flow Control Inc.

Stonel product center

26271 US Hwy 59, Fergus Falls, MN 56537 USA .

Tel. +1 218 739 5774.

sales.stonel@valmet.com

valmet.com/flowcontrol

Subject to change without prior notice.

Neles, Neles Easyflow, Jamesbury, Stonel, Valvcon and Flowrox, and certain other trademarks, are either registered trademarks or trademarks of Valmet Oyj or its subsidiaries in the United States and/or in other countries.

