

# 1/2" – 2-1/2" (DN 15 – 65) standard port and 1/2" – 2" (DN 15 – 50) full port Jamesbury™ series 4000 ball valves

The Jamesbury series 4000 ball valves offer the three most desirable attributes of high-quality valves: exceptional performance, great versatility, and economical cost.

This valve line includes both standard-port valves (to 2-1/2" [DN 65]) and full-port valves (to 2" [DN 50]) with three available end connections—threaded end, socket weld, and butt weld.

There are two basic groups of Series 4000 valves.



## Fire-Tite™ Valves

The first consists of Fire-Tite valves fire-tested to meet API 607 requirements. They are ideal for handling petroleum products and other flammable or hazardous substances, as well as for an extremely broad range of normal and corrosive services. These Series 4000 valves are available in materials conforming to NACE MR0103 requirements, and specifically prepared for oxygen or high-vacuum service. They are also available to conform to ASME, API, BS, ISO, DIN and MSS standards. Standard body and trim materials for Fire-Tite valves are carbon steel with 316 stainless steel trim and all 316 stainless steel. Seat material options are PTFE (T) and Xtreme™ (X) seats for applications involving chemicals, petrochemicals, acids, caustics and steam. Delrin® (R) seats are for higher pressures, while PFA (B) seats resist the effects of polymerizing monomers such as butadiene and styrene. Metal (D) seats are also available for use with high-temperature fluids, saturated steam, and other heat-transfer media at pressures to 300 psi (20.7 bar) and temperatures to 600°F (316 °C).

## Non-Fire-Tite Valves

Non Fire-Tite valves are available in the same body and trim materials as Fire-Tite valves with a wider range of seat material options. Xtreme (X) seats are the standard seat material, while PTFE (T), UHMW (U) polyethylene seats and PEEK (L) seats are also available.

## Features and benefits

- Xtreme seat provides longer life, expanded performance boundaries, and greater value.
- Polymeric flexible lip-seat design offers tight shut-off in either direction and extended cycle life with minimum maintenance.
- Available to meet ASME Class 800 for 1/2" - 2" RB & 1/2" - 1-1/2" FB and ASME 400 for 2-1/2" RB & 2" FB standards per B16.34, B31.1, B31.3, and B31.4. CWP ratings shown on p11.
- 3-piece construction facilitates servicing.
- Fire-Tite version with non-metallic seats meets API 607.
- Standard materials meet requirements of NACE MR0103 and MR0175 (see p12)

## Features and benefits

For 1/2" – 2" (DN 15 – 50) standard port and 1/2" – 1-1/2" (DN 15 – 40) full port valves

- Patented stem seal system is live loaded and engineered to assure long sealing life.
- ISO 5211 Bonnet for global conformity.
- CE Marking option.
- Stainless steel linkage for VPVL, V-Series and ADC-Series actuators has a guided coupling to align topworks during assembly and eliminate side load stress on stem seals for long life, clean environment and reduced maintenance.
- For most seat materials, weld end valves do not require disassembly before welding in-line. Refer to Installation, Maintenance, and Operating instructions (IMO) for details.

## Valve Performance and Value

### 1/2" - 2" (DN 15 - 50) Standard Port and 1/2" - 1-1/2" (DN 15 - 40) Full Port Valves

Patented stem seal (70017915) has 3 engineered sealing zones to provide multiple barriers for long term sealing.

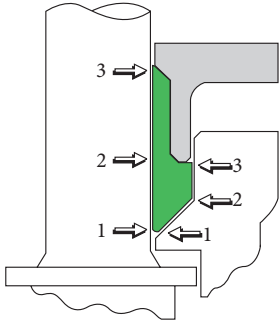

Handle with Slide Lock

Internal Entry Stem

ISO bonnet pad for standardized mounting of actuators and accessories.

Compression plate with disc springs for uniform stem seal compression to extend cycle life.

Flexible lip seats adjust automatically for changing pressures, temperatures and wear. Xtreme seats, PTFE, PEEK, PFA, Delrin, UHMW Polyethylene and metal seats available.

Thrust bearings.

Heavy wall thickness and bolt cross section.

TFM and graphite seals for a tight joint that outperforms API 607 requirements.

Full interchangeability of body and end caps for standard or full port. Threaded, socket weld and butt weld end connections available.

Permanently attached corrosion resistant metal nameplate for positive identification on all ASME and API valves.

For 2" (DN 50) full bore and 2-1/2" (DN 65) standard port, refer to page 6. All constructions marked comply with MSS SP-25.

## Xtreme Seat Performance and Value

Xtreme seats provide longer life, expanded performance boundaries, and the greatest possible value. Xtreme seats are made of a unique material that resulted from a technological breakthrough in our polymer research lab.

The material is a fluoropolymer-based blend that provides superior quarter-turn performance.

## The Ultimate Process Automation Package

for VPVL Pneumatic Actuators, V-Series and ADC-Series Electric Actuators

For 1/2" - 2" (DN 15 - 50) Standard Port and 1/2" - 1-1/2" (DN 15 - 40) Full Port Series 4000

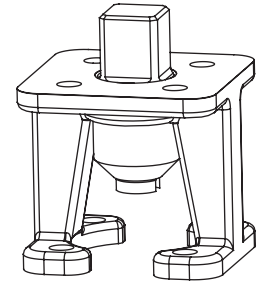
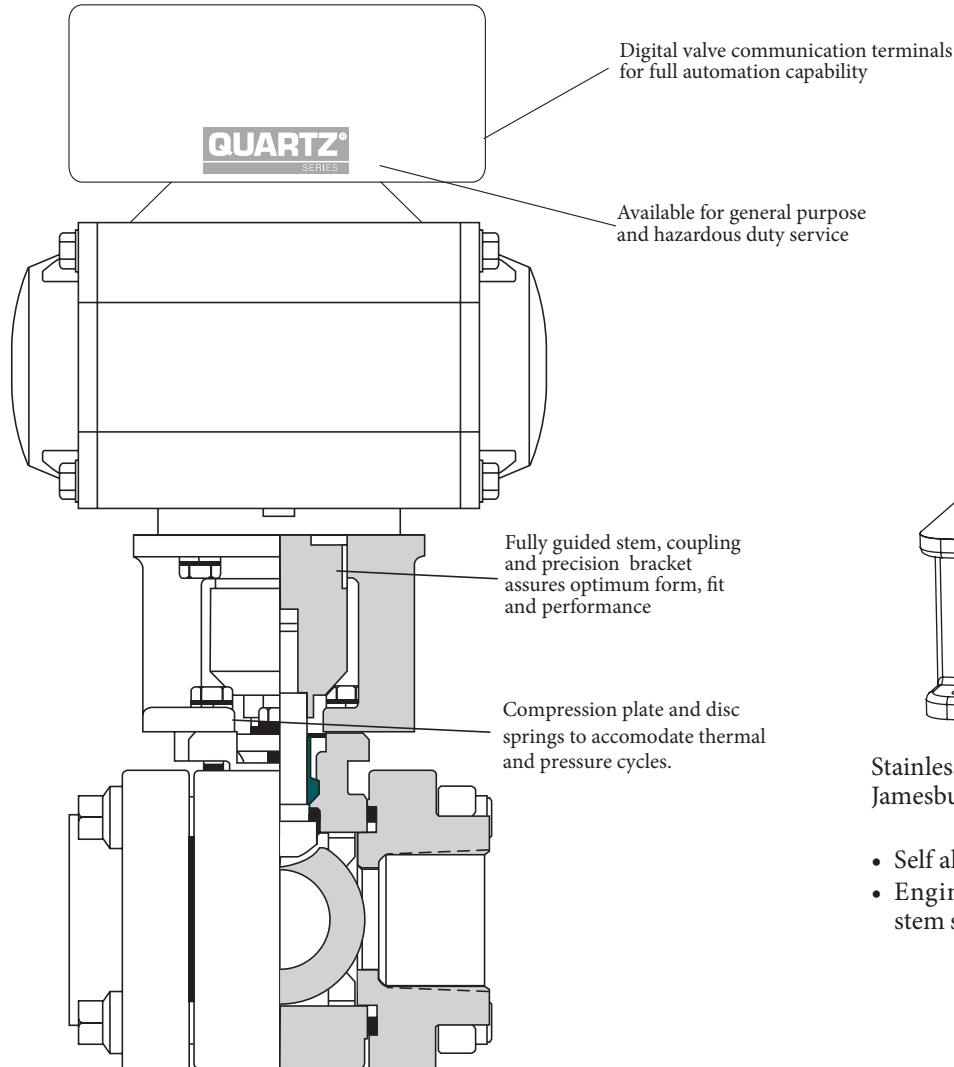

Stainless steel linkages for Jamesbury ISO Actuators

- Self aligning
- Engineered for optimum stem seal performance

## Automation Performance and Value

Series 4000 valves combined with Jamesbury actuators, network capable valve monitors and communication devices offer a total value and performance package. Available with pneumatic Valv-Powr™ VPVL actuators, V-Series and ADC-Series electric actuators and with Stonel™ Quartz™, Eclipse™, and Hawkeye™ digital monitors or VCTs, the packages have a wide range of applications. Visit our website at [www.valmet.com/flowcontrol](http://www.valmet.com/flowcontrol).

## Valve Seat Ratings

These ratings are based on differential pressure with valve ball in the fully closed position and refer to seats only. Refer to valve body ratings on page 11 to be sure that all components are satisfactory for the application.

Valves in carbon steel are suitable for service to -20°F (-29°C), valves in 316 stainless steel to -100 °F (-73 °C) or -40°F (-40°C) with Delrin seats. Lower temperature limits for body boltings are B7: -20 °F (-29 °C), B7M: -50 °F (-46 °C), L7M: -60 °F (-51°C), B8: -100 °F (-73°C).

**1/2" - 2" (DN 15-50) Standard Port,  
1/2" - 1-1/2" (DN 15-40) Full Port Valves**

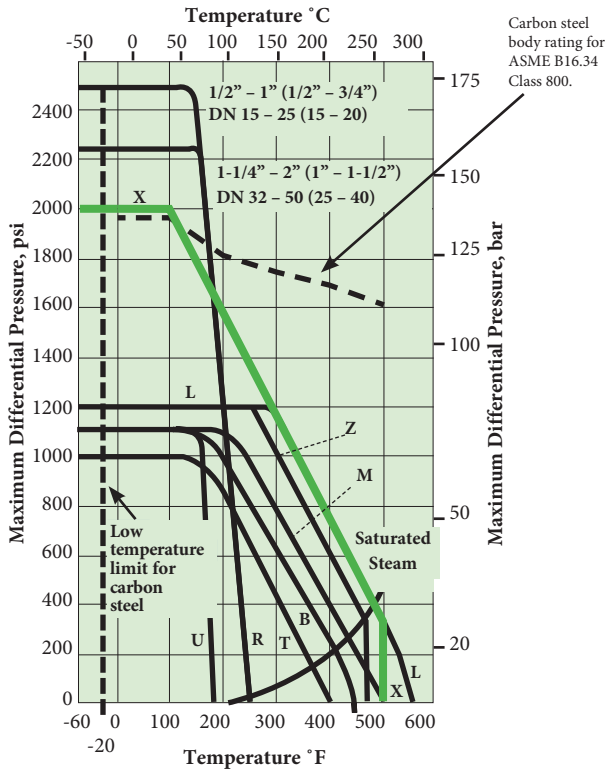

**2-1/2" (DN 65) Standard Port,  
2" (DN 50) Full Port Valves**

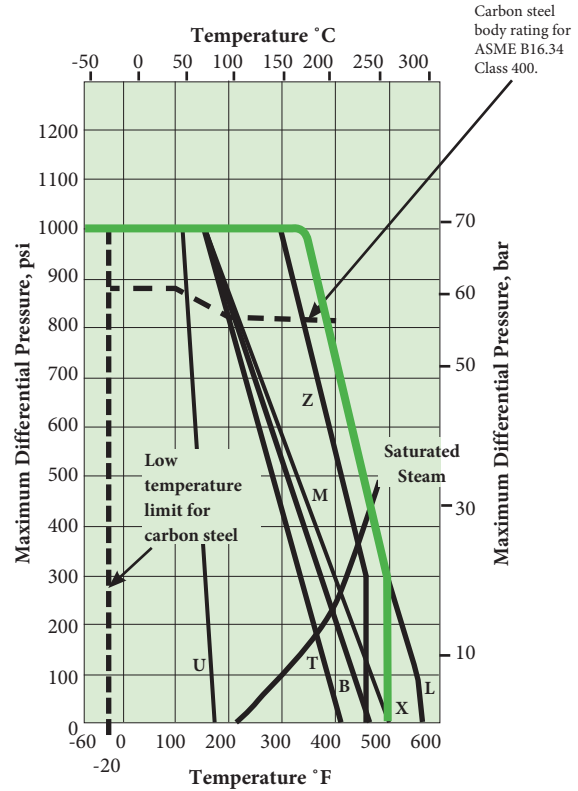

X-Xtreme Seats T-PTFE M-Filled PTFE R-Delrin L-PEEK  
U-UHMW polyethylene B-PFA Z-TFM

\*Full port sizes in parenthesis.

**Note:** All 1/2" (DN 15) Series 4000 valves have 1/2" (DN 15) port.

## Metal-Seated Valves

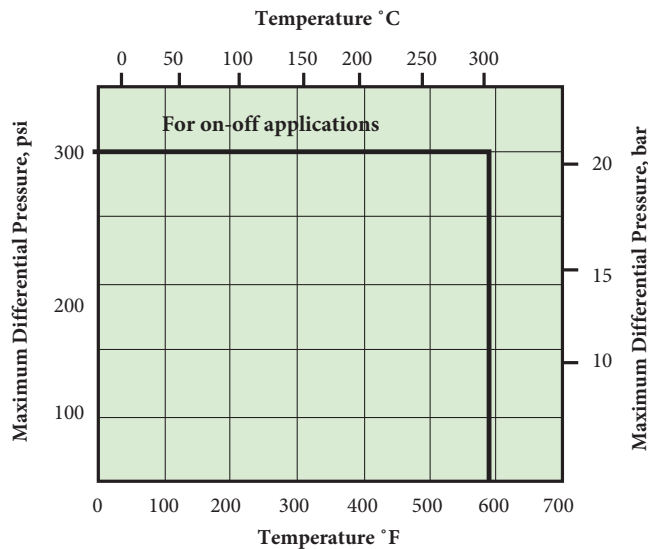

Dimensions

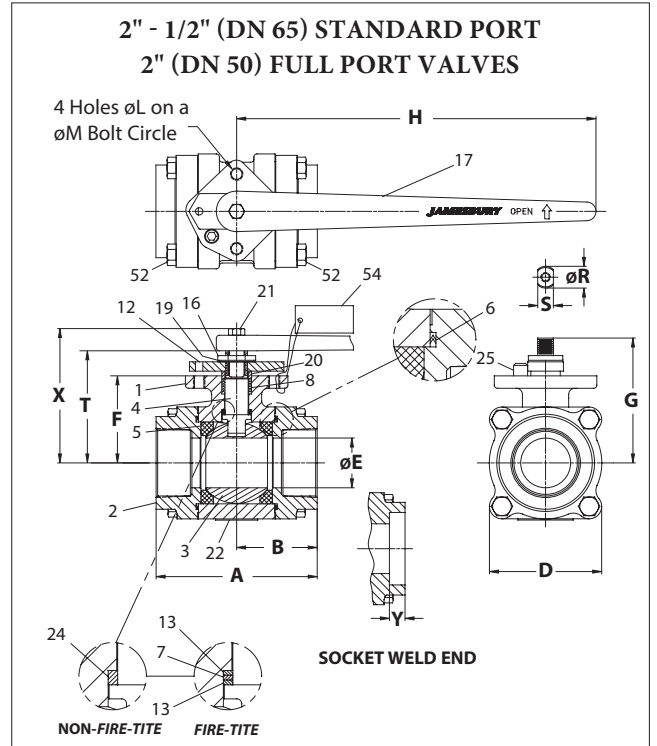
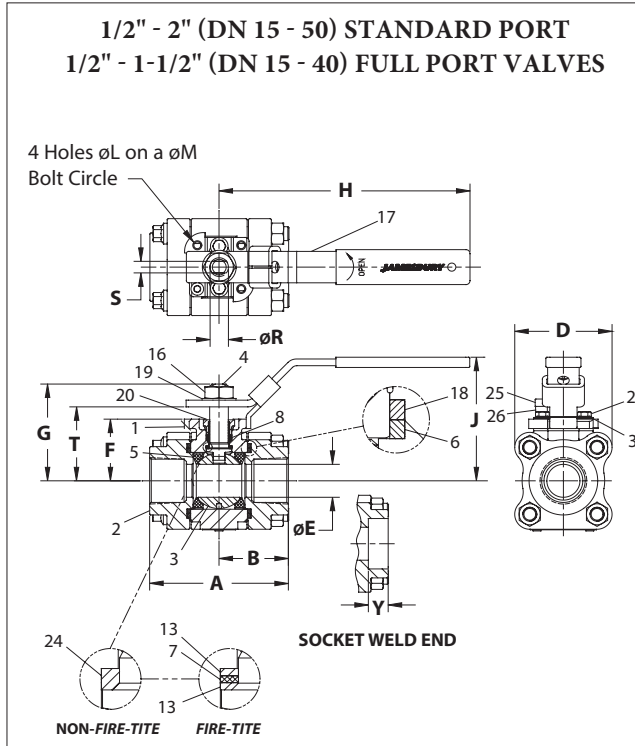

Approximate Dimensions - Inches																		
Valve Size inches	Screwed End & Socket Weld Valves		Butt Weld Valves		Common Dimensions													Approx. Weight lb
	A	B	A	B	D	E	F	G	H	J	L	M	R	S	T	X	Y	
<b>Standard Port</b>																		
1/2	2.59	1.29	2.80	1.40	2.06	0.50	1.06	1.63	5.00	2.36	M5	1.42	0.31	0.18	1.28	-	0.41	1.9
3/4	3.01	1.50	3.36	1.68	2.25	0.69	1.22	1.79	5.00	2.52	M5	1.42	0.31	0.18	1.43	-	0.53	2.7
1	3.69	1.85	3.90	1.95	2.59	0.88	1.65	2.58	6.50	3.29	M5	1.65	0.50	0.31	1.99	-	0.53	4.8
1-1/4	4.22	2.11	4.56	2.28	2.84	1.00	1.78	2.71	6.50	3.42	M5	1.65	0.50	0.31	2.12	-	0.53	6.3
1-1/2	4.58	2.29	5.40	2.70	3.33	1.25	2.08	3.30	8.00	4.27	M6	1.97	0.62	0.37	2.54	-	0.53	9.8
2	5.11	2.55	5.90	2.95	3.66	1.50	2.26	3.49	8.00	4.46	M6	1.97	0.62	0.37	2.73	-	0.64	12.7
2-1/2	6.47	3.22	-	-	4.50	2.00	3.50	5.00	14.00	-	1/2-13	3.00	0.88	0.63	4.38	5.38	0.64	25.5
<b>Full Port</b>																		
1/2	2.59	1.29	2.80	1.40	2.06	0.50	1.06	1.63	5.00	2.36	M5	1.42	0.31	0.18	1.28	-	0.41	1.9
3/4	3.69	1.85	3.90	1.95	2.59	0.88	1.65	2.58	6.50	3.29	M5	1.65	0.50	0.31	1.99	-	0.53	5.2
1	4.22	2.11	4.56	2.28	2.84	1.00	1.78	2.71	6.50	3.42	M5	1.65	0.50	0.31	2.12	-	0.53	6.8
1-1/4	4.58	2.29	5.40	2.70	3.33	1.25	2.08	3.30	8.00	4.27	M6	1.97	0.62	0.37	2.54	-	0.53	10.3
1-1/2	5.11	2.55	5.90	2.95	3.66	1.50	2.26	3.49	8.00	4.46	M6	1.97	0.62	0.37	2.73	-	0.53	13.7
2	6.19	3.09	6.19	3.09	4.50	2.00	3.50	5.00	14.00	-	1/2-13	3.00	0.88	0.63	4.38	5.38	0.64	25.3

Approximate Dimensions - mm																		
Valve Size DN	Screwed End & Socket Weld Valves		Butt Weld Valves		Common Dimensions													Approx. Weight kg
	A	B	A	B	D	E	F	G	H	J	L	M	R	S	T	X	Y	
<b>Standard Port</b>																		
15	66	33	71	36	52	13	27	41	127	60	M5	36	8	5	33	-	10	0.9
20	76	38	85	43	57	18	31	45	127	64	M5	36	8	5	36	-	13	1.2
25	94	47	99	50	66	22	42	66	165	84	M5	42	13	8	51	-	13	2.2
32	107	54	116	58	72	25	45	69	165	87	M5	42	13	8	54	-	13	2.9
40	116	58	137	69	85	32	53	84	203	108	M6	50	16	9	65	-	13	4.4
50	130	65	150	75	93	38	57	89	203	113	M6	50	16	9	69	-	16	5.8
65	164	82	-	-	114	51	89	127	356	-	1/2-13	76	22	16	111	137	16	11.6
<b>Full Port</b>																		
15	66	33	71	36	52	13	27	41	127	60	M5	36	8	5	33	-	10	0.9
20	94	47	99	50	66	22	42	66	165	84	M5	42	13	8	51	-	13	2.4
25	107	54	116	58	72	25	45	69	165	87	M5	42	13	8	54	-	13	3.1
32	116	58	137	69	85	32	53	84	203	108	M6	50	16	9	65	-	13	4.7
40	130	65	150	75	93	38	57	89	203	113	M6	50	16	9	69	-	13	6.2
50	157	78	157	78	114	51	89	127	356	-	1/2-13	76	22	16	111	137	16	11.5

BILLS OF MATERIALS AND PARTS LIST			
Fire-Tite 1/2" - 2" (DN 15 - 50) Standard Port, 1/2" - 1-1/2" (DN 15 - 40) Full Port Valves			
Part No.	Part Name	Body Material	
		Carbon Steel (22)	316 Stainless Steel (36)
1	Body	Carbon steel ASTM A216 Type WCB	316 Stainless steel ASTM A351 Type CF8M
2	Body Cap	Carbon steel ASTM A216 Type WCB	316L Stainless steel ASTM A351 Type CF3M
3	Ball	316 Stainless steel, K-Monel, Hastelloy C	
4	Stem	316 Stainless steel, 17-4 PH Stainless steel, K-Monel, Hastelloy C	
5	Seat	Xtreme seats, PTFE, 17-4 PH, PFA, Delrin*#, UHMW polyethylene, as specified	
6/18	Body Seals	PTFE & Graphite, Spiral wound 316 Stainless steel graphite/PTFE (with PEEK or metal seats)	
7	Secondary Stem Seal	Graphite	
8	Primary Stem Seal	PTFE, TFM* (Xtreme-Seated Valves), Graphite (w/metal seats), UHMWPE (w/UHMWPE seats)	
10	Stem Guide	PEEK (Metal-Seated Valves)	
13	Stem Bearing	PTFE, Filled PTFE, (PEEK when metal-seated), (Delrin when Delrin-seated or PEEK), UHMWPE (w/UHMWPE seats)	
16	Hex Nut	316 Stainless steel	
17	Handle	Carbon steel (zinc plated)	300 Series Stainless steel
19	Lock Washer	400 Series Stainless steel	
20	Compression Plate	316 Stainless steel	
25	Socket Cap Screw	316 Stainless steel	
26	Handle Stop Spacer	316 Stainless steel	
29	Hex Cap Screw	316 Stainless steel	
31	Disc Springs	Inconel	
52	Body Bolt/Tie Rod	ASTM A193 Gr. B7	ASTM A193 Gr. B8M
53	Hex Nut	ASTM A194 Gr. 2H	ASTM A194 Gr. 8
54	Weld End Tag	Paper	

# Requires 17-4 PH stem

Non-Fire-Tite 1/2" - 1-1/2" (DN 15 - 40) Full Port & 1/2" - 2" (DN 15 - 50) Standard Port Valves			
Part No.	Part Name	Body Material	
		Carbon Steel (22)	316 Stainless Steel (36)
1	Body	Carbon steel ASTM A216 Type WCB	316 Stainless steel ASTM A351 Type CF8M
2	Body Cap	Carbon steel ASTM A216 Type WCB	316L Stainless steel ASTM A351 Type CF3M
3	Ball	316 Stainless steel, K-Monel, Hastelloy C	
4	Stem	316 Stainless steel, 17-4 PH Stainless steel, K-Monel, Hastelloy C	
5	Seat	Xtreme seats, PTFE, PEEK #, as specified	
6/18	Body Seal	TFM & Graphite, Spiral wound 316 Stainless steel graphite/PTFE (with PEEK seats)	
8	Primary Stem Seal	PTFE, Graphite (with PEEK seats)	
10	Stem Guide	PEEK (PEEK seated valves)	
13	Stem Bearing	Filled PTFE (PEEK when PEEK-seated)	
16	Hex Nut	316 Stainless steel	
17	Handle	Carbon steel (Zinc plated)	300 Series Stainless steel
19	Lock Washer	400 Series Stainless steel	
20	Compression Plate	316 Stainless steel	
24	Stem Bearing	Filled PTFE (PEEK when PEEK-seated)	
25	Socket Cap Screw	316 Stainless steel	
26	Handle Stop Spacer	316 Stainless steel	
29	Hex Cap Screw	316 Stainless steel	
31	Disc Springs	Inconel	
52	Body Bolt/Tie Rod	ASTM A193 Gr. B7	ASTM A193 Gr. B8M
53	Hex Nut	ASTM A194 Gr. 2H	ASTM A194 Gr. 8
54	Weld End Tag	Paper	

# Requires 17-4 PH stem

BILLS OF MATERIALS AND PARTS LIST			
Fire-Tite 2" (DN 50) Full Port and 2 1/2" (DN 65) Standard Port Valves			
Part No.	Part Name	Body Material	
		Carbon Steel (22)	316 Stainless Steel (36)
1	Body	Carbon steel ASTM A216 Type WCB	316 Stainless steel ASTM A351 Type CF8M
2	Body Cap	Carbon steel ASTM A216 Type WCB	316L Stainless steel ASTM A351 Type CF3M
3	Ball	316 Stainless steel	
4	Stem	316 Stainless steel or 17-4 PH Stainless steel	
5	Seat	Xtreme seats, PTFE, 17-4 PH, as specified	
6	Body Seal	Spiral wound 316 Stainless steel graphite/PTFE	
7	Secondary Stem Seal	Graphite	
8	Stem Seal	PTFE, TFM (Xtreme-Seated Valves)	
12	Indicator Stop	316 Stainless steel	
16	Stem Nut	Carbon steel	Stainless steel
17	Handle	Ductile Iron	
19	Shakeproof Washer	Carbon steel	
21	Compression Ring	316 Stainless steel	
22	Identification Tag	Stainless steel	
24	Stem Bearing	Filled PTFE (PEEK when metal-seated)	
25	Hex Cap Screw**	ASTM A193 Gr. B7, B7M, A320 Gr. L7M	ASTM A193 Gr. B7, B8, A453 Gr. 660
52	Body Bolt/Tie Rod**	ASTM A193 Gr. B7, B7M, A320 Gr. L7M	ASTM A193 Gr. B7, B8, A453 Gr. 660
53	Hex Nut**	ASTM A194 Gr. 2H, 2M, 7M	ASTM A194 Gr. 2H, 2M, A453 Gr. 660
54	Weld End Tag	Paper	

\*\* A193 Gr. B7 Body Fasteners unless otherwise specified.

Non-Fire-Tite 2" (DN 50) Full Port and 2-1/2" (DN 65) Standard Port Valves			
Part No.	Part Name	Body Material	
		Carbon Steel (22)	316 Stainless Steel (36)
1	Body	Carbon steel ASTM A216 Type WCB	316 Stainless steel ASTM A351 Type CF8M
2	Body Cap	Carbon steel ASTM A216 Type WCB	316L Stainless steel ASTM A351 Type CF3M
3	Ball	316 Stainless steel	
4	Stem	316 Stainless steel or 17-4 PH Stainless steel (PEEK-seated valves)	
5	Seat	Xtreme seats, PTFE, PEEK, UHMW PE, as specified	
6	Body Seal	Spiral wound 316 Stainless steel graphite/PTFE, EPT (UHMWPE seated valves)	
8	Stem Seal	PTFE, TFM (Xtreme-Seated Valves), UHMW PE (UHMW PE-seated valves)	
12	Indicator Stop	316 Stainless steel	
16	Stem Nut	Carbon steel	Stainless steel
17	Handle	Ductile Iron	
19	Shakeproof Washer	Carbon steel	
21	Compression Ring	316 Stainless steel	
22	Identification Tag	Stainless steel	
24	Stem Bearing	Filled PTFE (Xtreme and PTFE seats) same as seat material for PEEK and UHMW PE Seats	
25	Hex Cap Screw**	ASTM A193 Gr. B7, B7M, A320 Gr. L7M	ASTM A193 Gr. B7, B8, A453 Gr. 660
52	Body Bolt/Tie Rod**	ASTM A193 Gr. B7, B7M, A320 Gr. L7M	ASTM A193 Gr. B7, B8, A453 Gr. 660
53	Hex Nut**	ASTM A194 Gr. 2H, 2M, 7M	ASTM A194 Gr. 2H, 2M, A453 Gr. 660
54	Weld End Tag	Paper	

\*\* A193 Gr. B7 Body Fasteners unless otherwise specified.

## VALVE TORQUE DATA

Use these torque charts for Series 4000 valves as a guide for actuator selection. For torque output values and actuator selection tables refer to actuator bulletins.

Additional requirements may be imposed by media characteristics, trim, and frequency of valve operation.

For difficult service (slurries, semi-solids) increase values by 50%. If in doubt, select a larger actuator.

Values shown in the charts are based on using standard factory procedures for valve-actuator assembly.

**Xtreme (X) and TFM (Z) Seated Standard Port Valves  
(Full-port sizes in parentheses)**

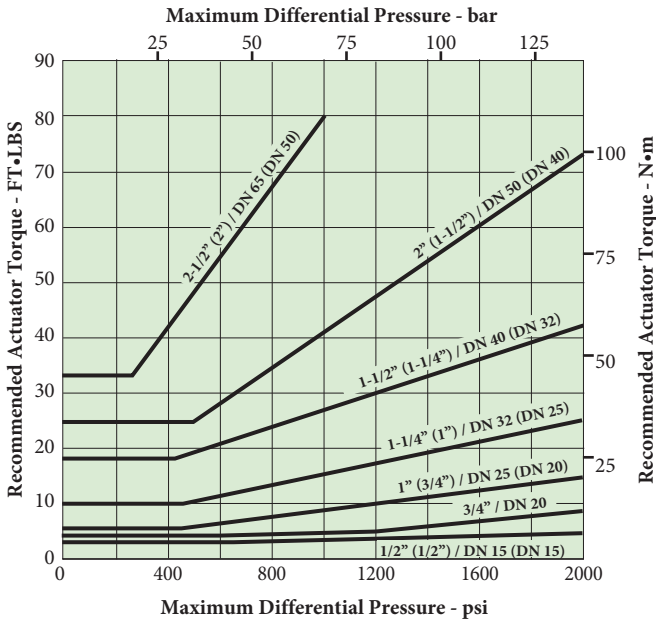

**Metal (D) Seated Standard Port Valves  
(Full-port sizes in parentheses)**

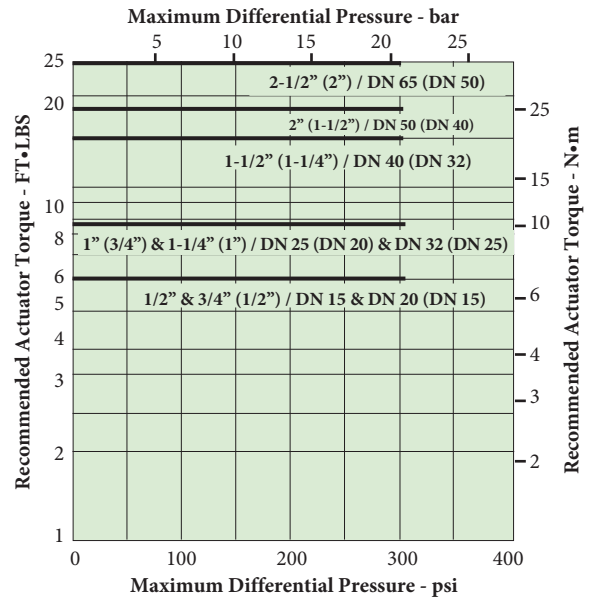

**PTFE (T) Seated Standard Port Valves**

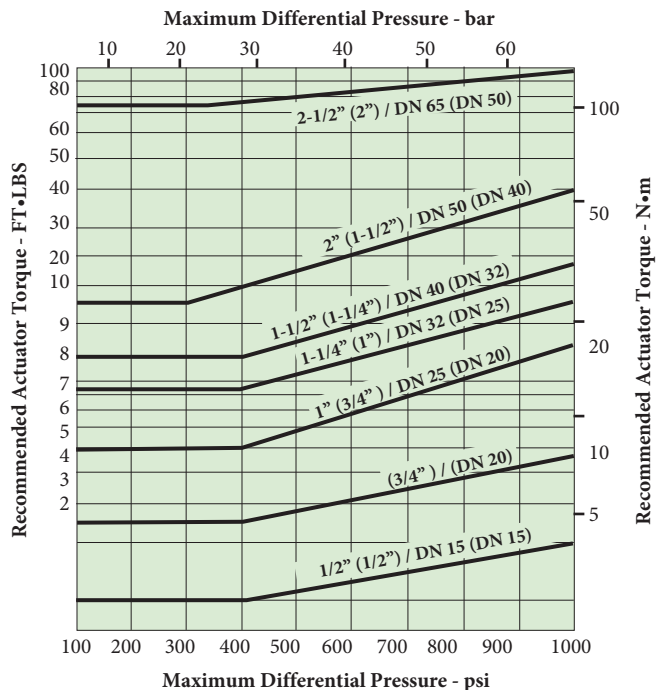



### VALVE TORQUE DATA (CONTINUED)

**PEEK (L) Seated Standard Port Valves**  
(Full port sizes in parentheses)

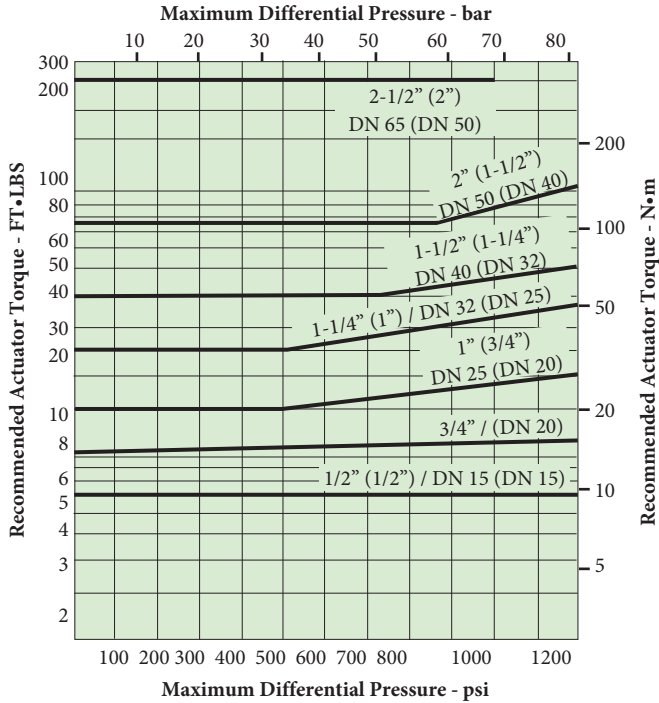

**Delrin (R) Seated Standard Port Valves**  
(Full port sizes in parentheses)

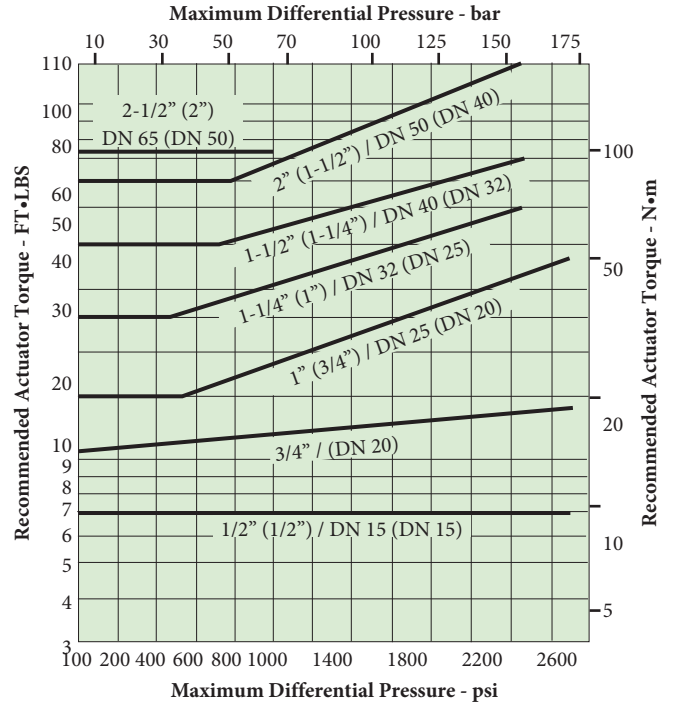

**UHMW (U) Polyethylene Seated Standard Port Valves**  
(Full port sizes in parentheses)

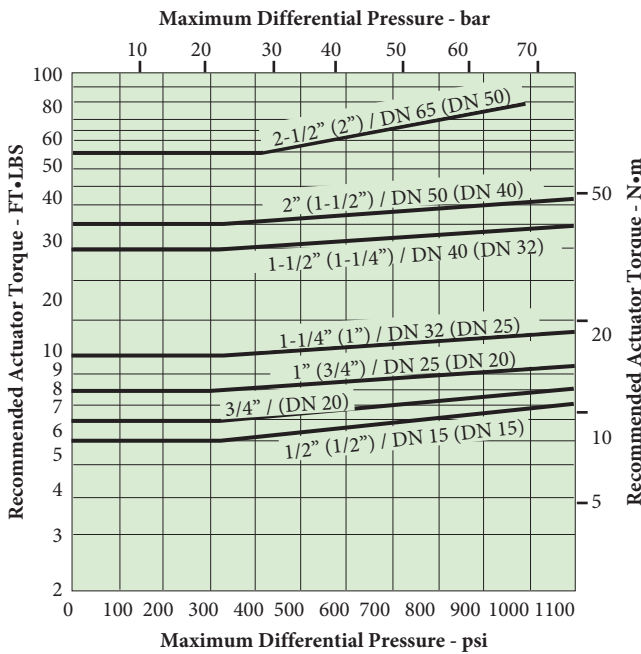

**PFA (B) Seated Standard Port Valves**

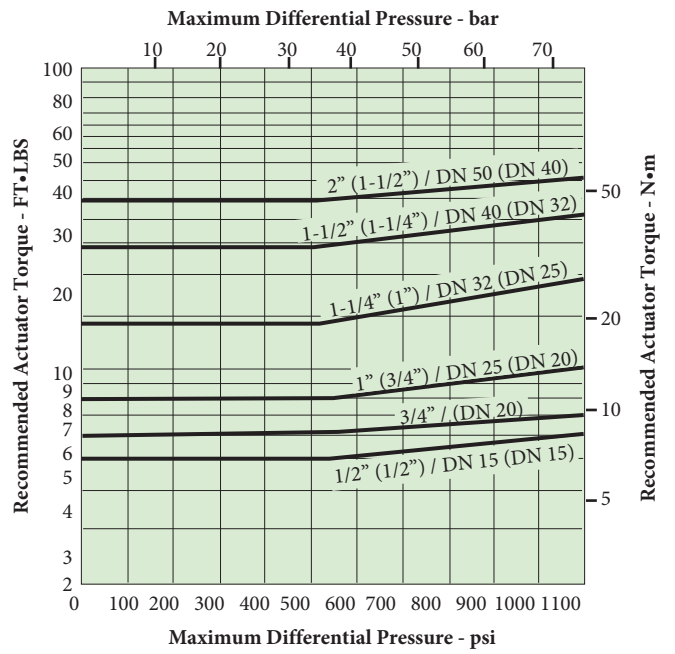

## ACTUATORS

Neles offers a full line of integrally designed actuators for automated systems and for easier control of inaccessible or remote valves. Pneumatic actuators that include double-acting and spring-return piston, vane, and rack and pinion units, spring-diaphragm types, and electric actuators are available for all valves. Electric actuators are available with both watertight and hazardous location enclosures. For further information on actuators for Series 4000 valves, see the following:

### Type

Type	Bulletin
Quadra-Powr™ QPX Spring Diaphragm Actuators	A110-4
Valv-Powr™ VPVL Rack and Pinion Actuators	A111-5
V-Series Electric Actuators	V200-1
ADC-Series Electric Actuators	V201-1

## ACCESSORIES

### Bonnet Extensions SE-096, 097 & 098

4" (102 mm) bonnet extensions are available for applications that require insulated pipe, which are particularly useful for automated products. Bonnet extensions can also be used to prevent interference between actuators and companion pipelines and equipment. They are ideal for units that require locking lever or locking oval handle capability.

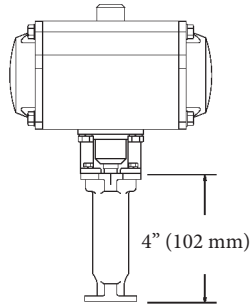

Oval handles with slide-lock  
Optional oval handle saves space and may be padlocked to retain the valve in the open or closed position.

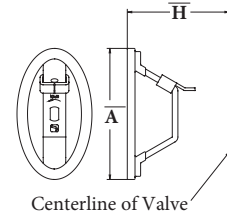

### Stainless steel linkages for Jamesbury ISO Actuators

- Self aligning
- Engineered for optimum stem seal performance

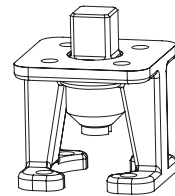

### Stem Extensions SE-093, 094 & 095

A standard 4" (102 mm) stem extension is offered for Series 4000 valves (1/2" – 2") for improved accessibility, particularly when used in insulated pipelines. Stem extension kits can be ordered factory-mounted or shipped separately for field mounting.

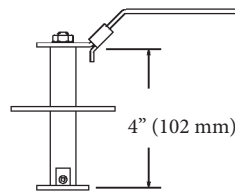

### Cavity Fillers

Cavity fillers are available in 4000 series valves. The fillers are PTFE material when ordered with a TT seat and seal code and Xtreme material when ordered with a XT seat and seal code. Cavity fillers are used in processes where cross contamination is a concern. Food processing, pharma-chemicals, cosmetics, paints, solvents, finishes and dyes are typical applications where fillers are employed.

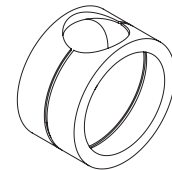

### Round Handles

Series 4000 ball valves have optional round handles available. To order handles separately, specify the part number shown in the accessories table below.

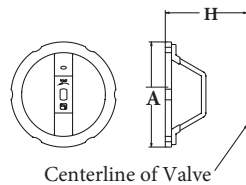

Accessories Table - inches (DN/mm)

Valve Size*		Bonnet/Stem† Extension	Stem Extension	Locking Oval	Round	Round/Oval Handle		Allowable Max. Torque FT•LBS (N•m)	
Standard Port	Full Port					Dimension A	Dimension H	Round	Oval
1/2" (15)	1/2" (15)	SE-096	SE-093	112-0108-30	112-0105-30	4.00 (101.6)	2.96 (75.2)	9 (14)	9 (14)
3/4" (20)	—	SE-096	SE-093	112-0108-30	112-0105-30	4.00 (101.6)	3.11 (79.0)	9 (14)	9 (14)
1" (25)	3/4" (20)	SE-097	SE-094	112-0109-30	112-0106-30	4.50 (114.3)	3.70 (94.0)	18 (25)	18 (25)
1-1/4" (32)	1" (25)	SE-097	SE-094	112-0109-30	112-0106-30	4.50 (114.3)	3.83 (97.3)	18 (25)	18 (25)
1-1/2" (40)	1-1/4" (32)	SE-098	SE-095	112-0110-30	112-0107-30	5.75 (146.0)	4.75 (120.7)	25 (34)	25 (34)
2" (50)	1-1/2" (40)	SE-098	SE-095	112-0110-30	112-0107-30	5.75 (146.0)	4.94 (125.5)	25 (34)	25 (34)
2-1/2" (65)	2" (50)	—	SE-014	—	—	—	—	—	—

\* Specify LD 64 when a locking device is required for 2" (DN 50) full bore and 2-1/2" (DN 65) standard port valves.

† For valves with PEEK (L), Delrin (R) or 17-4 PH SS (D) seats.

## SPECIFICATIONS

Series 4000 valves are available in types that meet the following industry specifications

Specification	Description
ASME B1.20.1	Pipe Threads
ASME B16.11	Steel Fitting Socket Welding & Thread
ASME B16.25	Buttwelding Ends
ASME B16.34	Valves-Flanged and Buttwelding Ends
ASME B31.1	Power Piping
ASME B31.3	Chemical Plant & Petroleum Refining Piping
ASME B31.4	Liquid Petroleum Piping
API 598	Valve Inspection & Testing
API 607	Fire Test for Soft-seated Valves (Div. of Refining)
API 608	Metal Ball Valves - Flanged, Threaded and Welding End
BS 21	Specification for pipe threads for tubes and fittings where pressure-tight joints are made on the threads (metric dimensions)
DIN 2999-1	Pipe threads for tubes and fittings; parallel internal thread and taper external thread; tread dimensions
ISO 17292	Metal Ball Valves for petroleum, petrochemical and allied industries

ISO 7-1	Pipe threads where pressure-tight joints are made on the threads -- Part 1: Dimensions, tolerances and designation
MSS SP-25	Standard Marking System for Valves
MSS SP-55	Quality Standard for Steel Fittings for Valves
MSS SP-72	Ball Valves with Flanged or Buttweld End
NACE MR0103	Materials Resistant to Sulfide Stress Cracking in Corrosive Petroleum Refining Environments
ISO 5211	Industrial Valves – Part-turn actuator attachment

## Flow Data

The table below provides flow coefficients,  $C_v$ , of Series 4000 valves. The  $C_v$  values represent the flow of water at +60 °F through the valve in U.S. gallons per minute at a pressure drop of 1 psi.

Valve Size		Standard port $C_v^*$	Full port $C_v^*$
Inches	DN		
1/2	15	13	13
3/4	20	33	40
1	25	44	65
1-1/4	32	46	90
1-1/2	40	95	135
2	50	111	251
2-1/2	65	216	—

\* $C_v = 1.167 K_v$ .

## Valve Body Ratings

These are the maximum working pressure ratings of the valve body only. The seat ratings on page 4 determine the practical pressure limitation in actual service. Working pressure rating is at -20 °F to +100 °F (-29 °C to +38 °C).

## Standard Version - Body Rating

Valve Size*		Working Pressure - Body Material: Carbon Steel and 316 Stainless Steel	
Inches	DN	psi	bar
1/2 - 1 (1/2 - 3/4)	15 - 25 (15 - 20)	2500	172
1-1/4 - 2 (1 - 1-1/2)	32 - 50 (25 - 40)	2250	155
2-1/2 (2)	65 (50)	1000	69

\*Full port sizes in parentheses

## Maximum Leakage Rates

All series 4000 valves are factory tested with air. Polymeric seated valves are verified to be bubble tight using 100 psi air. Metal seats are also tested with air to ensure that leakage does not exceed the rates shown below.

Valve Size - inches		Leakage Rate - scfm at Differential Pressure		
Standard Port	Full Port	100 psi	200 psi	300 psi
1/2	1/2	5.0	7.0	8.6
3/4	—	7.0	9.9	12.1
1 - 2	3/4 - 1-1/2	9.0	12.7	15.5
—	2	11.0	14.0	17.0

Valve Size - DN		Leakage Rate - m <sup>3</sup> /hr Differential Pressure		
Standard Port	Full Port	7 bar	14 bar	20 bar
15	15	8.5	11.9	14.6
20	—	11.9	16.8	20.6
25 - 50	20 - 40	15.3	21.6	26.3
—	50	18.7	23.8	28.8

## ASME Version - Body Rating

Temperature	ASME Class 800 1/2" - 2" (DN 15 - 50) Standard Port 1/2" - 1-1/2" (DN 15 - 40) Full Port		ASME Class 400 2-1/2" (DN 65) Standard Port 2" (DN 50) Full Port	
	Carbon Steel	Stainless Steel	Carbon Steel	Stainless Steel
°F	psi	psi	psi	psi
-20 to +100	1973	1920	990	960
200	1810	1653	900	825
300	1747	1493	875	745
400	1688	1368	845	685
500	1608	1275	800	635

Temperature	ASME Class 800 1/2" - 2" (DN 15 - 50) Standard Port 1/2" - 1-1/2" (DN 15 - 40) Full Port		ASME Class 400 2-1/2" (DN 65) Standard Port 2" (DN 50) Full Port	
	Carbon Steel	Stainless Steel	Carbon Steel	Stainless Steel
°C	bar	bar	bar	bar
-29 to +38	136	132	68.3	66.2
100	124	113	61.9	56.2
150	120	103	60.3	51.2
200	117	95	58.5	47.6
250	112	89	55.7	44.4

## HOW TO ORDER SERIES 4000 BALL VALVES

To specify a Series 4000 valve, select the body style, the combination of body and trim material, the proper seat material, and the appropriate body bolts for the application. Code numbers are fully descriptive of a valve. They are made up of size and a figure designation based on the following coding:

**EXAMPLE:** This order code calls for a 3/4" standard port NPT Fire-Tite valve with carbon steel body, 316 stainless steel ball and stem, Xtreme seats and PTFE seals, and ASTM A193 Gr. B7 bolts with ASTM A194 Gr 2H nuts.

1	2	3	4	5	6	7	8	9
3/4	4A	—	—	22	36	XT	B	1

1	Size - 1/2 – 2-1/2 (DN 15-65) Standard Port, 1/2 – 2 (DN 15-50) Full Port						
inches	1/2	3/4	1	1-1/4	1-1/2	2	2-1/2
DN	15	20	25	35	40	50	65

2	Body Style
4A	Standard port NPT
4B	Full port NPT
4C	Std. Port socket weld
4D	Full port socket weld
4F	Std. port butt weld Schedule-5
4G	Std. port butt weld Schedule-10
4H	Std. port butt weld Schedule-40
4J	Full port butt weld Schedule-5
4K	Full port butt weld Schedule-10
4L	Full port butt weld Schedule-40
4M	Std. port NPT x soc. weld ends
4N	Full port NPT x soc. weld ends
4P	Full port butt weld Schedule 80
4Q	Std. port butt weld Schedule 80
4R	Std. port ISO 7 Rp (BS21 parallel DIN 2999)
4S	Std. port ISO 7 Rc (BS21 taper)
4T	Full port ISO 7 Rp (BS21 parallel DIN 2999)
4U	Full port ISO 7 Rc (BS21 taper)

3	Configuration
—	(no entry if Fire-Tite)
X	Non-Fire-Tite
B	ASME B16.34
M3*	ASME B16.34 with metric nameplate

4	Special Service
—	(no entry if standard)
N	NACE MR0103 w/exposed body fasteners
O	Oxygen
Q	Cavity Filler (Xtreme w/ XT, PTFE w/ TT)
V	High vacuum
VC	High vacuum certified
C	Chlorine
TG	Top Ground
STGR	Top and Bottom Ground
LA	Standard Emission Pak™ w/o Leakoff Connection
LL	Standard Emission Pak™ with Leakoff Connection

5	Body Material
22 <sup>6</sup>	Carbon steel
36 <sup>6</sup>	316 Stainless steel

6	Ball and stem material
00	Same as body (Carbon steel not available)
36 <sup>6</sup>	316 Stainless steel
HB <sup>6</sup>	316 Stainless steel ball, 17-4 PH stem (required for DH, RT & LG seats & seals)
71 <sup>6</sup>	Monel
73	Hastelloy C

7	Seat and Seal Material	
	Seats	Seal
<b>Standard Fire-Tite Options</b>		
XT <sup>5</sup>	Xtreme	TFM & Graphite
TT	PTFE	PTFE & Graphite
DH	17-4 PH Stainless steel	Graphite
UU	UHMW Polyethylene*	UHMW PE & Graphite
RT <sup>2,4</sup>	Delrin*	PTFE & Graphite
BT	PFA	PTFE & Graphite
<b>Non-Fire-Tite Options</b>		
TT	PTFE	PTFE
UB	UHMW Polyethylene	UHMW Polyethylene & EPT
LG <sup>2,4</sup>	PEEK*	PEEK & Graphite
LT <sup>2,4</sup>	PEEK**	PTFE & Graphite

8	Valve Model
A	Series 4000 Model A**
B	Series 4000 Model B*

9	Body Fasteners	
	Bolts or Tie Rods	Nuts
1	ASTM A193 Gr. B7	ASTM A194 Gr. 2H
2	ASTM A193 Gr. B8 or B8M2	ASTM A194 Gr. 8, 8C, 8F, 8M, 8MN, 8N, 8P, or 8T
5 <sup>1</sup>	ASTM A193 Gr. B7M	ASTM A194 Gr. 2HM
7 <sup>1</sup>	ASTM A320 Gr. sL7M	ASTM A194 Gr. 7M
8 <sup>1</sup>	ASTM A453 Gr. 660	ASTM A453 Gr. 660

\* For 1/2" – 2" (DN 15 – 50) standard port and 1/2" – 1-1/2" (DN 15 – 40) full bore valves

\*\* For 2" (DN 50) full bore and 2-1/2" (DN 65) standard port only.

1 For NACE MR0103 service, if buried or insulated.

2 Requires high strength stem.

3 Valves larger than 1" (DN 25) are CE marked.

4 Not a self-relieving seat design.

5 Seats fully rated to CL800 pressure up to 100°F.

TFM is a registered trademark of Dyneon Co.

Delrin is a registered trademark of DuPont Co.

6 Material meets NACE requirements for sour environments. For valves to be in full compliance with NACE, both the body (sign #5) and trim (sign #6) must meet the NACE requirement.

**NOTE:** As the use of the valve is application specific, a number of factors should be taken into account when selecting a valve for a given application. Therefore, some of the applications in which the valves are used are outside the scope of this document. If you have any questions concerning the use, application or compatibility of the valve with the intended service, contact Valmet for more information.

Subject to change without prior notice.

Neles, Neles Easyflow, Jamesbury, Stonel, Valcon and Flowrox, and certain other trademarks, are either registered trademarks or trademarks of Valmet Oyj or its subsidiaries in the United States and/or in other countries.

For more information [www.neles.com/trademarks](http://www.neles.com/trademarks)

### Valmet Flow Control Oy

Vanha Porvoontie 229, 01380 Vantaa, Finland.

Tel. +358 10 417 5000.

[www.valmet.com/flowcontrol](http://www.valmet.com/flowcontrol)

